

## Description

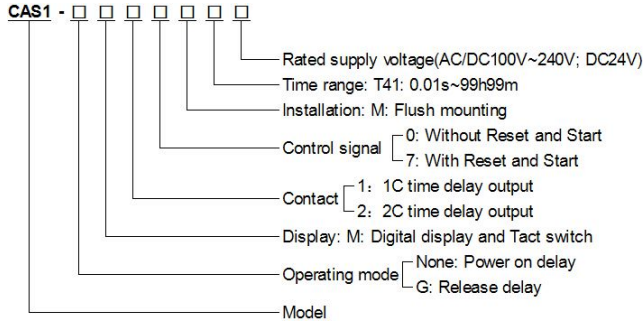

CAS1-□M□□MT41



## Specification

Model	CAS1-M20MT41	CAS1-M17MT41	CAS1-M27MT41	CAS1-GM20MT41	CAS1-GM17MT41	CAS1-GM27MT41
Rated Supply Voltage	AC/DC100~240V, DC24V					
Time range	0.01s~99.99s, 1s~99m99s, 1m~99h99m					
Repetitive error	The range of time delay > 1s, Er ≤ 1%, The range of time delay < 1s, Dr ≤ 50ms					
Operating mode	Power on delay			Release delay		
Contact	2C time delay	1C time delay	2C time delay	2C time delay	1C time delay	2C time delay
Rated Load of the Contact	3A AC220V(Resistive)					
Electrical Life	100000 operations min. (3 A at 250 VAC/30 VDC, resistive load)					
Ambient Temperature	-5°C~40°C					
Ambient Humidity	If the ambient temperature is 20°C, the RH ≤ 90%, if the ambient temperature is 40°C, the RH ≤ 50%.					
Altitude	≤ 2000m					
Installation	Flush mounting					

## Wiring Diagram

CAS1-M20MT41

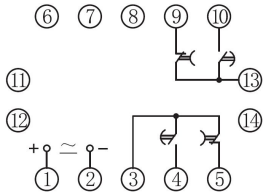

CAS1-M17MT41

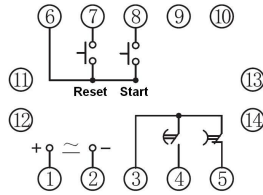

CAS1-M27MT41

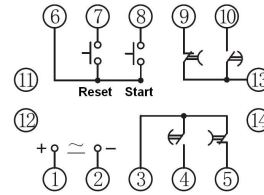

CAS1-GM20MT41

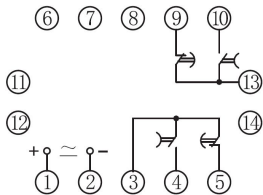

CAS1-GM17MT41

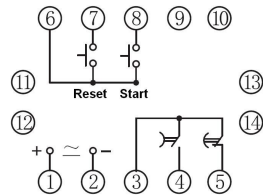

CAS1-GM27MT41

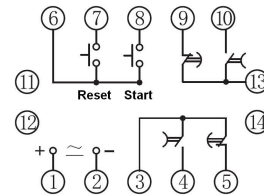

## Dimension(mm) and Installation(mm)

Panel and Dimension

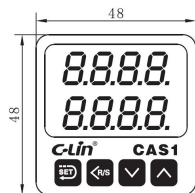

Mounting

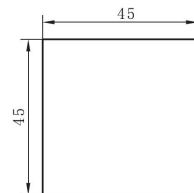
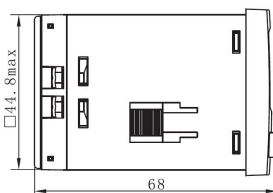

## Application(Samples as CAS1-M20MT41)

Samples01

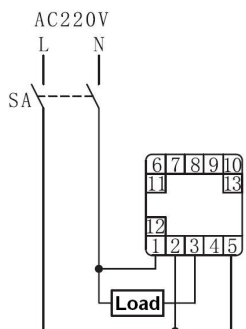

Samples02

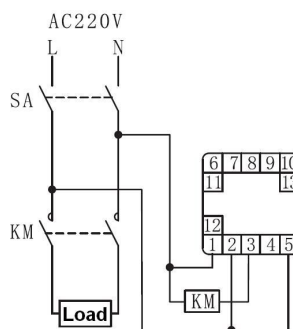

Samples03

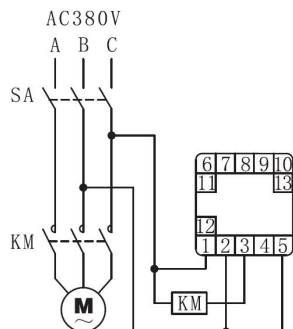

Samples04

